

ISO Star Series Valves

5/2 and 5/3 solenoid and air pilot actuated valves

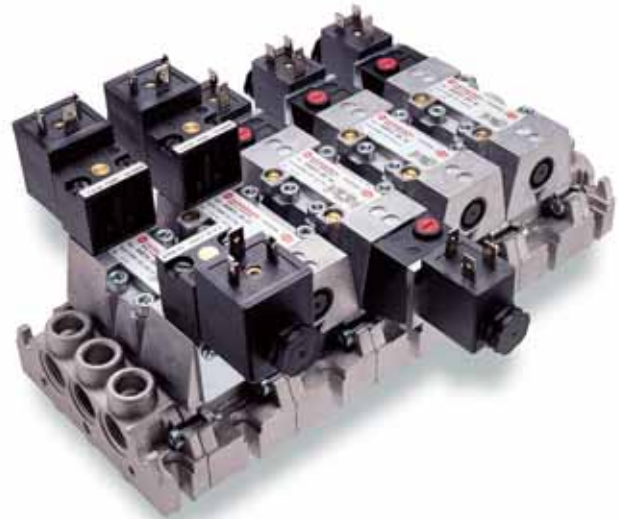

- NITUFF® coated non-corrosive spool and sleeve for long trouble free life (100 million plus cycles)**
- Integral flow controls for cylinder speed control on size #1, and #2 models**
- Low power solenoids with manual override options**
- End and CNOMO solenoid pilots**
- Base mounted soft start valves available**
- Minimal maintenance**

Technical Data

Medium:

Compressed air, 40µm filtered, lubricated or non-lubricated

Operation:

Glandless spool valve, solenoid pilot or air pilot actuated

Mounting:

On sub-bases

Sizes:

#1, #2, #3

Operating Pressure:

Maximum pressure

145 psig (10 bar) solenoid pilot actuated valves with internal pilot supply

232 psig (16 bar) solenoid pilot actuated valves with external pilot supply

232 psig (16 bar) air pilot actuated valves

Flow Characteristics (unregulated):

Size	Cv	l/min
#1	1.2	5.5
#2	2.4	10.7
#3	4.4	17.9

Ambient Temperature:

5°F* to 122°F (-15°C to 50°C) solenoid pilot actuated valves

5°F* to 176°F (-15°C to 80°C) air pilot actuated valves

*Consult our Technical Service for use below 36°F (2°C)

Materials:

Die cast aluminum body. Hard anodized, Teflon coated, matched aluminum spool and sleeve. Viton and nitrile rubber seals. Zinc die cast locking plate. POM plastic parts. Zinc plated screws. Brass flow regulators.

Ordering Information

To order select model number, add voltage code and connector code, e.g. SXE 0573-A60-00/13JB for a 5/2 double end solenoid pilot size #1 valve with internal pilot air supply, integral flow regulators, shrouded push button lockable manual override, 22 mm coil 24V d.c. with cable grip connector.

5/2

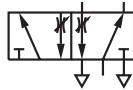

5/3

All ports blocked mid position

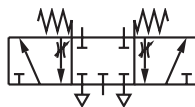

5/3

Center open exhaust mid position

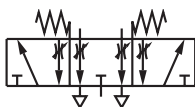

5/3

Center open pressure mid position

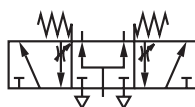

ISO Star Series Valves

5/2 and 5/3 solenoid and air pilot actuated valves

5/2 Solenoid Pilot Actuated Valves

Model	Size	Flow Control	Pilot Supply	Operator	Return	Operating Pressure psig (bar)	Pilot Pressure psig (bar)	Weight lb. (kg)
SXE9573-A70-00***†	#1	-	Internal	Solenoid	Air Spring	14.5 - 145 (1 - 10)	-	0.74 (0.33)
SXE9574-A70-00***†	#2	-	Internal	Solenoid	Air Spring	14.5 - 145 (1 - 10)	-	1.34 (0.59)
SXE9575-A70-00***†	#3	-	Internal	Solenoid	Air Spring	14.5 - 145 (1 - 10)	-	1.93 (0.85)
SXE9573-A80-00***†	#1	Integral	Internal	Solenoid	Air Spring	14.5 - 145 (1 - 10)	-	0.74 (0.33)
SXE9574-A80-00***†	#2	Integral	Internal	Solenoid	Air Spring	14.5 - 145 (1 - 10)	-	1.34 (0.59)
SXE9573-A75-00***†	#1	-	External	Solenoid	Air Spring	26" Hg - 232 (-0.9 - 16)	14.5 - 145 (1 - 10)	0.74 (0.33)
SXE9574-A75-00***†	#2	-	External	Solenoid	Air Spring	26" Hg - 232 (-0.9 - 16)	14.5 - 145 (1 - 10)	1.34 (0.59)
SXE9575-A75-00***†	#3	-	External	Solenoid	Air Spring	26" Hg - 232 (-0.9 - 16)	14.5 - 145 (1 - 10)	1.93 (0.85)
SXE9573-A85-00***†	#1	Integral	External	Solenoid	Air Spring	26" Hg - 232 (-0.9 - 16)	14.5 - 145 (1 - 10)	0.74 (0.33)
SXE9574-A85-00***†	#2	Integral	External	Solenoid	Air Spring	26" Hg - 232 (-0.9 - 16)	14.5 - 145 (1 - 10)	1.34 (0.59)
SXE0573-A50-00***†	#1	-	Internal	Solenoid	Solenoid	29 - 145 (2 - 10)	-	1.02 (0.45)
SXE0574-A50-00***†	#2	-	Internal	Solenoid	Solenoid	29 - 145 (2 - 10)	-	1.63 (0.72)
SXE0575-A50-00***†	#3	-	Internal	Solenoid	Solenoid	29 - 145 (2 - 10)	-	2.18 (0.96)
SXE0573-A60-00***†	#1	Integral	Internal	Solenoid	Solenoid	29 - 145 (2 - 10)	-	1.02 (0.45)
SXE0574-A60-00***†	#2	Integral	Internal	Solenoid	Solenoid	29 - 145 (2 - 10)	-	1.63 (0.72)
SXE0573-A55-00***†	#1	-	External	Solenoid	Solenoid	26" Hg - 232 (-0.9 - 16)	29 - 145 (2 - 10)	1.02 (0.45)
SXE0574-A55-00***†	#2	-	External	Solenoid	Solenoid	26" Hg - 232 (-0.9 - 16)	29 - 145 (2 - 10)	1.63 (0.72)
SXE0575-A55-00***†	#3	-	External	Solenoid	Solenoid	26" Hg - 232 (-0.9 - 16)	29 - 145 (2 - 10)	2.18 (0.96)
SXE0573-A65-00***†	#1	Integral	External	Solenoid	Solenoid	26" Hg - 232 (-0.9 - 16)	29 - 145 (2 - 10)	1.02 (0.45)
SXE0574-A65-00***†	#2	Integral	External	Solenoid	Solenoid	26" Hg - 232 (-0.9 - 16)	29 - 145 (2 - 10)	1.63 (0.72)

5/3 Solenoid Pilot Actuated Valves

Model	Size	Flow Control	Valve Function*	Pilot Supply	Operator	Operator	Operating Pressure psig (bar)	Pilot Pressure psig (bar)	Weight lb. (kg)
SXE9673-A60-00***†	#1	Integral	APB	Internal	Solenoid	Solenoid	29 - 145 (2 - 10)	-	1.02 (0.45)
SXE9674-A60-00***†	#2	Integral	APB	Internal	Solenoid	Solenoid	29 - 145 (2 - 10)	-	1.63 (0.72)
SXE9675-A50-00***†	#3	-	APB	Internal	Solenoid	Solenoid	29 - 145 (2 - 10)	-	2.18 (0.96)
SXE9673-A65-00***†	#1	Integral	APB	External	Solenoid	Solenoid	26" Hg - 232 (-0.9 - 16)	29 - 145 (2 - 10)	1.02 (0.45)
SXE9674-A65-00***†	#2	Integral	APB	External	Solenoid	Solenoid	26" Hg - 232 (-0.9 - 16)	29 - 145 (2 - 10)	1.63 (0.72)
SXE9675-A55-00***†	#3	-	APB	External	Solenoid	Solenoid	26" Hg - 232 (-0.9 - 16)	29 - 145 (2 - 10)	2.18 (0.96)
SXE9773-A60-00***†	#1	Integral	COE	Internal	Solenoid	Solenoid	29 - 145 (2 - 10)	-	1.02 (0.45)
SXE9774-A60-00***†	#2	Integral	COE	Internal	Solenoid	Solenoid	29 - 145 (2 - 10)	-	1.63 (0.72)
SXE9775-A50-00***†	#3	-	COE	Internal	Solenoid	Solenoid	29 - 145 (2 - 10)	-	2.18 (0.96)
SXE9773-A65-00***†	#1	Integral	COE	External	Solenoid	Solenoid	26" Hg - 232 (-0.9 - 16)	29 - 145 (2 - 10)	1.02 (0.45)
SXE9774-A65-00***†	#2	Integral	COE	External	Solenoid	Solenoid	26" Hg - 232 (-0.9 - 16)	29 - 145 (2 - 10)	1.63 (0.72)
SXE9775-A55-00***†	#3	-	COE	External	Solenoid	Solenoid	26" Hg - 232 (-0.9 - 16)	29 - 145 (2 - 10)	2.18 (0.96)
SXE9873-A60-00***†	#1	Integral	COP	Internal	Solenoid	Solenoid	29 - 14 5 (2 - 10)	-	1.02 (0.45)
SXE9874-A60-00***†	#2	Integral	COP	Internal	Solenoid	Solenoid	29 - 14 5 (2 - 10)	-	1.63 (0.72)
SXE9875-A50-00***†	#3	-	COP	Internal	Solenoid	Solenoid	29 - 14 5 (2 - 10)	-	2.18 (0.96)
SXE9873-A65-00***†	#1	Integral	COP	External	Solenoid	Solenoid	26" Hg - 232 (-0.9 - 16)	29 - 145 (2 - 10)	1.02 (0.45)
SXE9874-A65-00***†	#2	Integral	COP	External	Solenoid	Solenoid	26" Hg - 232 (-0.9 - 16)	29 - 145 (2 - 10)	1.63 (0.72)
SXE9874-A65-00***†	#3	-	COP	External	Solenoid	Solenoid	26" Hg - 232 (-0.9 - 16)	29 - 145 (2 - 10)	2.18 (0.96)

***Insert 3-digit voltage code from Voltage Codes and Replacement Coils table below.

† Insert letter from Connector Option Codes.

* Valve Function Designations: APB = All Ports Blocked
COE = Center Open Exhaust
COP = Center Open Pressure

Part Number Example

SXE9573-Z70-0012JA

Where "12J" is a 12V d.c. coil with a 22 mm connector interface, and "A" is a solenoid without connector.

Voltage Codes and Replacement Coils

Voltage	22 mm Coil with connector interface acc. to Industrial Standard			30 mm Coil with connector interface acc. to DIN 43650 table "A"		
	Code	Power Inrush/Hold	Coil Part.-no.	Code	Power Inrush/Hold	Coil Part.-no.
12 V d.c.	12J	2 W	54469-01	22N	1.5 W	V10633-A22N
24 V d.c.	13J	2 W	54469-02	23N	1.5 W	V10633-A23N
24 V 50/60 Hz	14J	4/2.5 VA	54469-04	24N	3/2 VA	V10633-A24N
48 V 50/60 Hz	16J	4/2.5 VA	54469-07	26N	3/2 VA	V10633-A26N
110/120 V 50/60 Hz	18J	4/2.5 VA	54469-03	28N	3/2 VA	V10633-A28N
220/240 V 50/60 Hz	19J	9/5.0 VA	54469-08	89N	10/8VA	V10633-A89N

Other Voltages available on request.

ISO Star Series Valves

5/2 and 5/3 solenoid and air pilot actuated valves

5/2 CNOMO Solenoid Pilot Actuated Valves

(Consult factory for lead times)

Model	Size	Flow Control	Pilot Supply	Operator	Return	Operating Pressure psig (bar)	Pilot Pressure psig (bar)	Weight lb. (kg)
SXE9573-Z70-90***†	#1	-	Internal	Solenoid	Air Spring	14.5 - 145 (1 - 10)	-	0.74 (0.33)
SXE9574-Z70-90***†	#2	-	Internal	Solenoid	Air Spring	14.5 - 145 (1 - 10)	-	1.34 (0.59)
SXE9575-Z70-90***†	#3	-	Internal	Solenoid	Air Spring	14.5 - 145 (1 - 10)	-	1.93 (0.85)
SXE9573-Z80-90***†	#1	Integral	Internal	Solenoid	Air Spring	14.5 - 145 (1 - 10)	-	0.74 (0.33)
SXE9574-Z80-90***†	#2	Integral	Internal	Solenoid	Air Spring	14.5 - 145 (1 - 10)	-	1.34 (0.59)
SXE9573-Z75-90***†	#1	-	External	Solenoid	Air Spring	26" Hg - 232 (-0.9 - 16)	14.5 - 145 (1 - 10)	0.74 (0.33)
SXE9574-Z75-90***†	#2	-	External	Solenoid	Air Spring	26" Hg - 232 (-0.9 - 16)	14.5 - 145 (1 - 10)	1.34 (0.59)
SXE9575-Z75-90***†	#3	-	External	Solenoid	Air Spring	26" Hg - 232 (-0.9 - 16)	14.5 - 145 (1 - 10)	1.93 (0.85)
SXE9573-Z85-90***†	#1	Integral	External	Solenoid	Air Spring	26" Hg - 232 (-0.9 - 16)	14.5 - 145 (1 - 10)	0.74 (0.33)
SXE9574-Z85-90***†	#2	Integral	External	Solenoid	Air Spring	26" Hg - 232 (-0.9 - 16)	14.5 - 145 (1 - 10)	1.34 (0.59)
SXE0573-Z50-90***†	#1	-	Internal	Solenoid	Solenoid	29 - 145 (2 - 10)	-	1.02 (0.45)
SXE0574-Z50-90***†	#2	-	Internal	Solenoid	Solenoid	29 - 145 (2 - 10)	-	1.63 (0.72)
SXE0575-Z50-90***†	#3	-	Internal	Solenoid	Solenoid	29 - 145 (2 - 10)	-	2.18 (0.96)
SXE0573-Z60-90***†	#1	Integral	Internal	Solenoid	Solenoid	29 - 145 (2 - 10)	-	1.02 (0.45)
SXE0574-Z60-90***†	#2	Integral	Internal	Solenoid	Solenoid	29 - 145 (2 - 10)	-	1.63 (0.72)
SXE0573-Z55-90***†	#1	-	External	Solenoid	Solenoid	26" Hg - 232 (-0.9 - 16)	29 - 145 (2 - 10)	1.02 (0.45)
SXE0574-Z55-90***†	#2	-	External	Solenoid	Solenoid	26" Hg - 232 (-0.9 - 16)	29 - 145 (2 - 10)	1.63 (0.72)
SXE0575-Z55-90***†	#3	-	External	Solenoid	Solenoid	26" Hg - 232 (-0.9 - 16)	29 - 145 (2 - 10)	2.18 (0.96)
SXE0573-Z65-90***†	#1	Integral	External	Solenoid	Solenoid	26" Hg - 232 (-0.9 - 16)	29 - 145 (2 - 10)	1.02 (0.45)
SXE0574-Z65-90***†	#2	Integral	External	Solenoid	Solenoid	26" Hg - 232 (-0.9 - 16)	29 - 145 (2 - 10)	1.63 (0.72)

5/3 CNOMO Solenoid Pilot Actuated Valves

(Consult factory for lead times)

Model	Size	Flow Control	Valve Function*	Pilot Supply	Operator	Operator psig (bar)	Operating Pressure psig (bar)	Pilot Pressure lb. (kg)	Weight
SXE9673-Z60-90***†	#1	Integral	APB	Internal	Solenoid	Solenoid	29 - 145 (2 - 10)	-	1.02 (0.45)
SXE9674-Z60-90***†	#2	Integral	APB	Internal	Solenoid	Solenoid	29 - 145 (2 - 10)	-	1.63 (0.72)
SXE9675-Z50-90***†	#3	-	APB	Internal	Solenoid	Solenoid	29 - 145 (2 - 10)	-	2.18 (0.96)
SXE9673-Z65-90***†	#1	Integral	APB	External	Solenoid	Solenoid	26" Hg - 232 (-0.9 - 16)	29 - 145 (2 - 10)	1.02 (0.45)
SXE9674-Z65-90***†	#2	Integral	APB	External	Solenoid	Solenoid	26" Hg - 232 (-0.9 - 16)	29 - 145 (2 - 10)	1.63 (0.72)
SXE9675-Z55-90***†	#3	-	APB	External	Solenoid	Solenoid	26" Hg - 232 (-0.9 - 16)	29 - 145 (2 - 10)	2.18 (0.96)
SXE9773-Z60-90***†	#1	Integral	COE	Internal	Solenoid	Solenoid	29 - 145 (2 - 10)	-	1.02 (0.45)
SXE9774-Z60-90***†	#2	Integral	COE	Internal	Solenoid	Solenoid	29 - 145 (2 - 10)	-	1.63 (0.72)
SXE9775-Z50-90***†	#3	-	COE	Internal	Solenoid	Solenoid	29 - 145 (2 - 10)	-	2.18 (0.96)
SXE9773-Z65-90***†	#1	Integral	COE	External	Solenoid	Solenoid	26" Hg - 232 (-0.9 - 16)	29 - 145 (2 - 10)	1.02 (0.45)
SXE9774-Z65-90***†	#2	Integral	COE	External	Solenoid	Solenoid	26" Hg - 232 (-0.9 - 16)	29 - 145 (2 - 10)	1.63 (0.72)
SXE9775-Z55-90***†	#3	-	COE	External	Solenoid	Solenoid	26" Hg - 232 (-0.9 - 16)	29 - 145 (2 - 10)	2.18 (0.96)
SXE9873-Z60-90***†	#1	Integral	COP	Internal	Solenoid	Solenoid	29 - 145 (2 - 10)	-	1.02 (0.45)
SXE9874-Z60-90***†	#2	Integral	COP	Internal	Solenoid	Solenoid	29 - 145 (2 - 10)	-	1.63 (0.72)
SXE9875-Z50-90***†	#3	-	COP	Internal	Solenoid	Solenoid	29 - 145 (2 - 10)	-	2.18 (0.96)
SXE9873-Z65-90***†	#1	Integral	COP	External	Solenoid	Solenoid	26" Hg - 232 (-0.9 - 16)	29 - 145 (2 - 10)	1.02 (0.45)
SXE9874-Z65-90***†	#2	Integral	COP	External	Solenoid	Solenoid	26" Hg - 232 (-0.9 - 16)	29 - 145 (2 - 10)	1.63 (0.72)
SXE9875-Z55-90***†	#3	-	COP	External	Solenoid	Solenoid	26" Hg - 232 (-0.9 - 16)	29 - 145 (2 - 10)	2.18 (0.96)

***Insert 3-digit voltage code from Voltage Codes and Replacement Coils.

* Valve Function Designations: APB = All Ports Blocked
COE = Center Open Exhaust
COP = Center Open Pressure

† Insert letter from Connector Option Codes.

Part Number Example

SXE9573-Z70-0012JA

Where "12J" is a 12V d.c. coil with a 22 mm connector interface, and "A" is a solenoid without connector.

Voltage Codes and Replacement Coils

Voltage	22 mm Coil with connector interface acc. to Industrial Standard			30 mm Coil with connector interface acc. to DIN 43650 table "A"		
	Code	Power Inrush/Hold	Coil Part.-no.	Code	Power Inrush/Hold	Coil Part.-no.
12 V d.c.	12J	2 W	54469-01	22N	1.5 W	V10633-A22N
24 V d.c.	13J	2 W	54469-02	23N	1.5 W	V10633-A23N
24 V 50/60 Hz	14J	4/2.5 VA	54469-04	24N	3/2 VA	V10633-A24N
48 V 50/60 Hz	16J	4/2.5 VA	54469-07	26N	3/2 VA	V10633-A26N
110/120 V 50/60 Hz	18J	4/2.5 VA	54469-03	28N	3/2 VA	V10633-A28N
220/240 V 50/60 Hz	19J	9/5.0 VA	54469-08	89N	10/8VA	V10633-A89N

Other Voltages available on request.

ISO Star Series Valves

5/2 and 5/3 solenoid and air pilot actuated valves

Part Number Example

SXE9573-Z70-0012JA

Where "12J" is a 12V d.c. coil with a 22 mm connector interface, and "A" is a solenoid without connector.

Voltage Codes and Replacement Coils

Voltage	22 mm Coil with connector interface acc. to Industrial Standard			30 mm Coil with connector interface acc. to DIN 43650 table "A"		
	Code	Power Inrush/Hold	Coil Part.-no.	Code	Power Inrush/Hold	Coil Part.-no.
12 V d.c.	12J	2 W	54469-01	22N	1.5 W	V10633-A22N
24 V d.c.	13J	2 W	54469-02	23N	1.5 W	V10633-A23N
24 V 50/60 Hz	14J	4/2.5 VA	54469-04	24N	3/2 VA	V10633-A24N
48 V 50/60 Hz	16J	4/2.5 VA	54469-07	26N	3/2 VA	V10633-A26N
110/120 V 50/60 Hz	18J	4/2.5 VA	54469-03	28N	3/2 VA	V10633-A28N
220/240 V 50/60 Hz	19J	9/5.0 VA	54469-08	89N	10/8VA	V10633-A89N

Other Voltages available on request.

Connector option codes and replacement connectors

Connector Option Codes Industrial standard	22 mm coil DIN 43650 table "A"	30 mm coil
A = Solenoid without connector		
B = Cable grip	54934-01	54933-05
C = 6 ft. molded cable, 0-240V a.c./V d.c.	54934-21	54933-06
5 = 6 ft. molded cable with indicator light surge suppression, 24V a.c./V d.c.	54934-30	54933-09
6 = 6 ft. molded cable with indicator light, 110V/50 Hz - 120V/60 Hz	54934-35	M/P43316/23

Other Connectors available on request.

5/2 Air Pilot Actuated Valves

Model	Size	Flow Control	Operator	Return	Operating Pressure psig (bar)	Pilot Pressure psig (bar)	Weight lb. (kg)
SXP9573-170-00B	#1	-	Air	Spring	26" Hg - 232 (-0.9 - 16)	23.2 - 232 (1.6 - 16)	0.47 (0.21)
SXP9574-170-00B	#2	-	Air	Spring	26" Hg - 232 (-0.9 - 16)	23.2 - 232 (1.6 - 16)	1.02 (0.45)
SXP9575-170	#3	-	Air	Spring	26" Hg - 232 (-0.9 - 16)	23.2 - 232 (1.6 - 16)	1.63 (0.72)
SXP9573-180-00B	#1	Integral	Air	Spring	26" Hg - 232 (-0.9 - 16)	23.2 - 232 (1.6 - 16)	0.47 (0.21)
SXP9574-180-00B	#2	Integral	Air	Spring	26" Hg - 232 (-0.9 - 16)	23.2 - 232 (1.6 - 16)	1.02 (0.45)
SXP0573-170-00B	#1	-	Air	Air	26" Hg - 232 (-0.9 - 16)	29 - 232 (2 - 16)	0.68 (0.30)
SXP0574-170-00B	#2	-	Air	Air	26" Hg - 232 (-0.9 - 16)	29 - 232 (2 - 16)	1.13 (0.50)
SXP0575-170	#3	-	Air	Air	26" Hg - 232 (-0.9 - 16)	29 - 232 (2 - 16)	1.63 (0.72)
SXP0573-180-00B	#1	Integral	Air	Air	26" Hg - 232 (-0.9 - 16)	29 - 232 (2 - 16)	0.68 (0.30)
SXP0574-180-00B	#2	Integral	Air	Air	26" Hg - 232 (-0.9 - 16)	29 - 232 (2 - 16)	1.13 (0.50)

5/3 Air Pilot Actuated Valves



Model	Size	Flow Control	Valve Function*	Operator	Operator	Operating Pressure psig (bar)	Pilot Pressure psig (bar)	Weight lb. (kg)
SXP9673-180-00B	#1	Integral	APB	Air	Air	26" Hg - 232 (-0.9 - 16)	29 - 232 (2 - 16)	0.57 (0.25)
SXP9674-180-00B	#2	Integral	APB	Air	Air	26" Hg - 232 (-0.9 - 16)	29 - 232 (2 - 16)	1.32 (0.58)
SXP9675-170	#3	-	APB	Air	Air	26" Hg - 232 (-0.9 - 16)	29 - 232 (2 - 16)	1.82 (0.80)
SXP9773-180-00B	#1	Integral	COE	Air	Air	26" Hg - 232 (-0.9 - 16)	29 - 232 (2 - 16)	0.57 (0.25)
SXP9774-180-00B	#2	Integral	COE	Air	Air	26" Hg - 232 (-0.9 - 16)	29 - 232 (2 - 16)	1.32 (0.58)
SXP9775-170	#3	-	COE	Air	Air	26" Hg - 232 (-0.9 - 16)	29 - 232 (2 - 16)	1.82 (0.80)
SXP9873-180-00B	#1	Integral	COP	Air	Air	26" Hg - 232 (-0.9 - 16)	29 - 232 (2 - 16)	0.57 (0.25)
SXP9874-180-00B	#2	Integral	COP	Air	Air	26" Hg - 232 (-0.9 - 16)	29 - 232 (2 - 16)	1.32 (0.58)
SXP9875-170	#3	-	COP	Air	Air	26" Hg - 232 (-0.9 - 16)	29 - 232 (2 - 16)	1.82 (0.80)

* Valve Function Designations:
 APB = All Ports Blocked
 COE = Center Open Exhaust
 COP = Center Open Pressure

ISO Star Series Valves

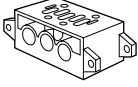
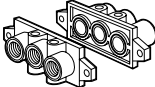
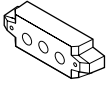

5/2 and 5/3 solenoid and air pilot actuated valves

Side Ported Modular Base Range

	Modular Sub-base Side Ported	Modular Sub-base End Plates (2)	Transition plate	Blanking disk
				
NPT #1 models	1001 (1/4)	1002 (3/8)	1009 (#1 #2)	1001-6-1
NPT #2 models	2101 (3/8)1	2102 (1/2)	2109 (#2 #3)	2106-1
NPT #3 models	3101 (3/4)1	3102-75-75 (3/4")2 3102-75-B (3/4") 3	-	

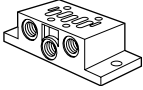
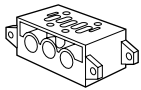
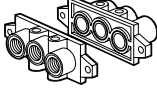
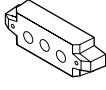

1-side and bottom ported 2-both ends ported 3-one end ported

VDMA 24 345 Base Range

VDMA 24 345	Form 'A' Single Station Sub-base Side Ported	Form 'C' Modular Sub-base Bottom Ported	Form 'D' Modular Sub-base End Plates (2)	Transition plate	Blanking disk * (dual supply)
					
NPT #1 models (1/4)	C/P19126	239-238B	239-289B	CQM/22152/3/24 #1#2	239-251
NPT #2 models (3/8)	C/P19132	239-242B	239-291B	CQM/22253/3/24 #2#3	239-252
NPT #3 models (1/2)	C/P19138	239-246B	239-293B	CQM/22354/3/24 #3#4	239-253
ISO G #1 models	M/P19126	CQM/22152/3/21	CQM/22152/3/22	CQM/22152/3/24 #1#2	FP8382
ISO G #2 models	M/P19132	CQM/22253/3/21	CQM/22253/3/22	CQM/22253/3/24 #2#3	FP8482
ISO G #3 models	M/P19138	CQM/22354/3/21	CQM/22354/3/22	CQM/22354/3/24 #3#4	FP8582

* Only suitable for specific base range.

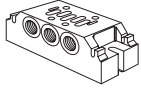
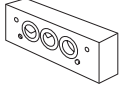
Universal Base Range

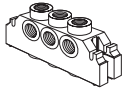
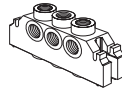
	Modular Sub-base Side and bottom ported	Transition Plate	Blanking Disk** (dual supply)	Side End Plate All Ports Closed	Single End Plate End Ports Open
					
ISO #1 models (G1/4)	CQM/22152/3/27	CQM/22152/3/29#1'2	M/P43173	CQM/22152/3/28	CQM/22152/3/31
ISO #2 models (G3/8)	CQM/22253/3/27		M/P43174	CQM/22253/3/28	CQM/22253/3/31

** Universal base range only.

Accessories

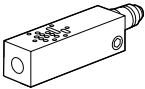
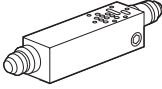
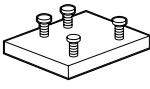
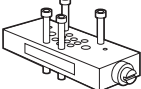
	Single Pressure Regulator port 1 regulated	Pressure Regulator ports 2 & 4 regulated	Blanking Plate	Sandwich Flow Control
				
#1 models	RM1A-8B†	DRM1A-8-8B†	CQM/22152/3/23	
#2 models	RM2A-8B†	DRM2A-8-8B†	CQM/22253/3/23	
#3 models	RM3A-8B†	-	CQM/22354/3/23	CQM/22354/3/26

† CNOMO style valves recommended

Sandwich Regulators (valve mounts to regulator, regulator mounts to subbase)

	Single Pressure port 1 regulated	Dual Pressure ports 2 & 4	Single Pressure port 2	Single Pressure Port 4
ISO #1	V71020-KB1	V71022-KB4	V71022-KB2	V71022-KB3
ISO #2	V71020-KC1	V71022-KC4	V71022-KC2	V71022-KC3
ISO #3	V71020-KD1	V71022-KD4	V71022-KD2	V71022-KD3

ISO Star Series Valves

5/2 and 5/3 solenoid and air pilot actuated valves

Dimensions in inches (mm)

SXE 9573 – A Models
Single End Solenoid Pilot Valves Size #1

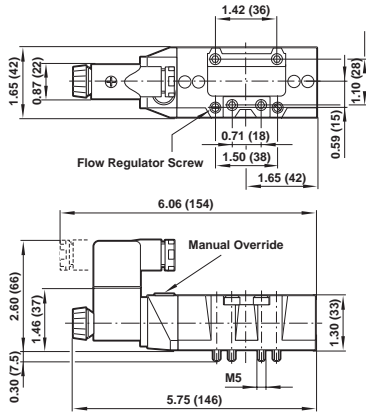

SXE 0573–A and SXE9*73–A Models
Double End Solenoid Pilot Valves Size #1

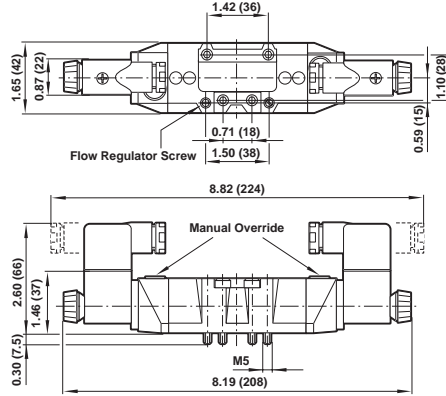

SXE 9573–Z Models
Single CNOMO Solenoid Pilot Valves Size #1

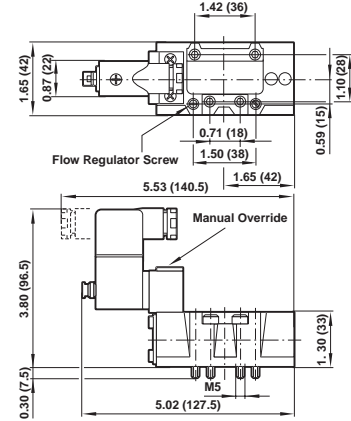

SXE 0573–Z and SXE 9*73–Z Models
Double CNOMO Solenoid Pilot Valves Size #1

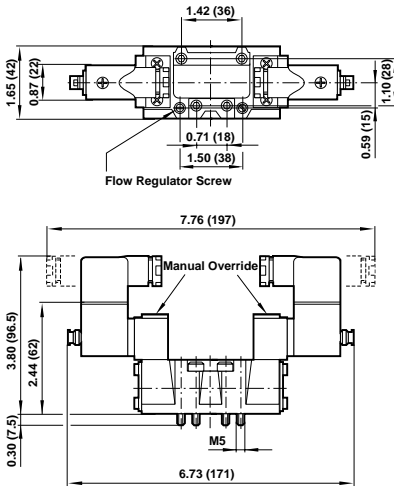

SXE 9574–A Models
Single End Solenoid Pilot Valves Size #2

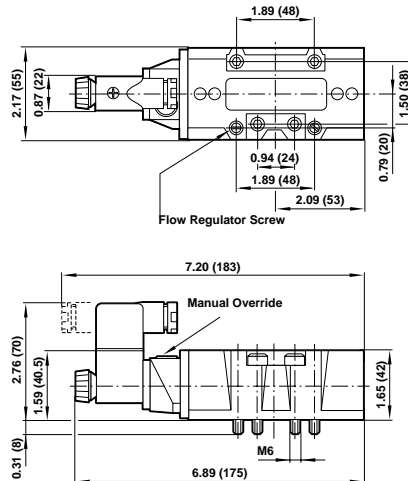

SXE 0574–A, SXE 9*74–A Models
Double End Solenoid Pilot Valves Size #2

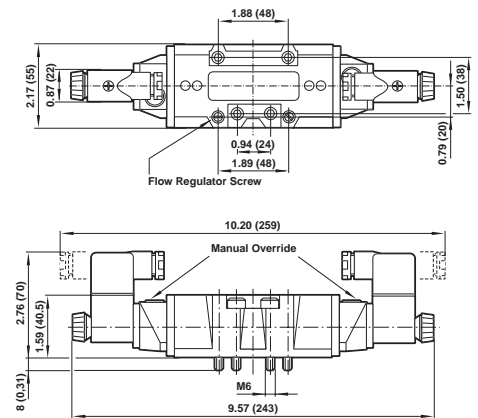

SXE 9574–Z Models
Single CNOMO Solenoid Pilot Valves Size #2

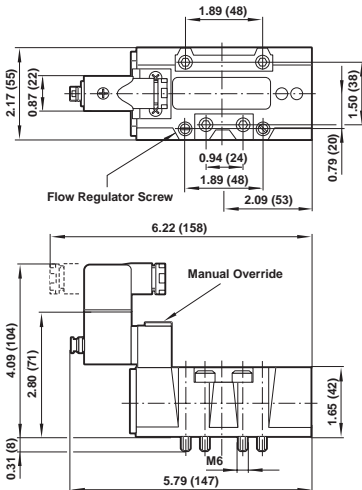

SXE 0574–Z and SXE 9*74–Z Models
Double CNOMO Solenoid Pilot Valves Size #2

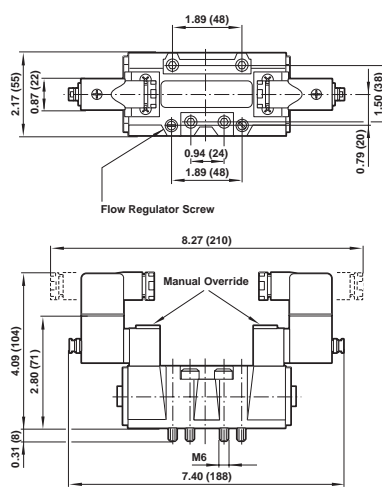

SXE 9575–A Models
Single End Solenoid Pilot Valves Size #3

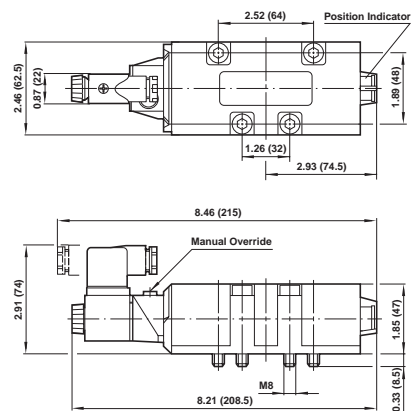

ISO Star Series Valves

5/2 and 5/3 solenoid and air pilot actuated valves

Dimensions in inches (mm)

SXE 0575-A and SXE 9*75-A Models
Double End Solenoid Pilot Valves Size #3

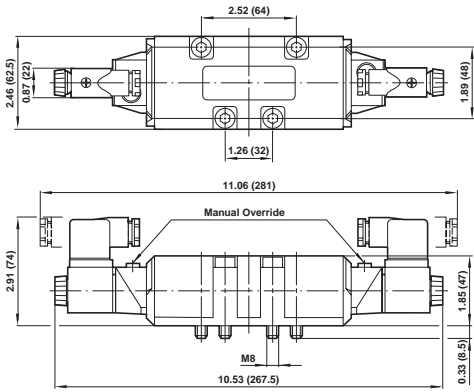

SXE 9575-Z Models
Single CNOMO Solenoid Pilot Valves Size #3

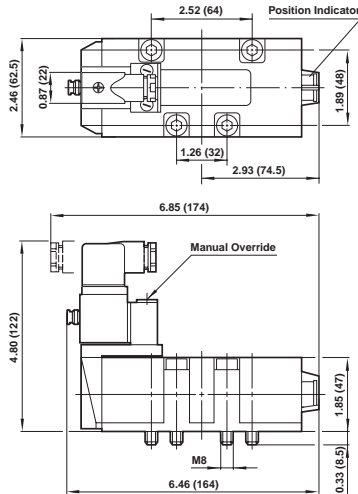

SXE 0575-Z and SXE 9*75-Z Models
Double CNOMO Solenoid Pilot Valves Size #3

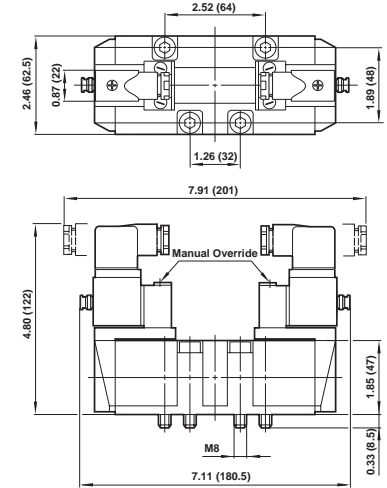

SXP 9573-1 Models
Single Air Pilot Valves Size #1 (5/2)

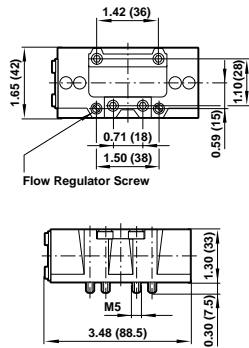

SXP 0573-1 and SXP 9*73-1 Models
Double Air Pilot, Spring Centered Valves
Size #1 (5/3)

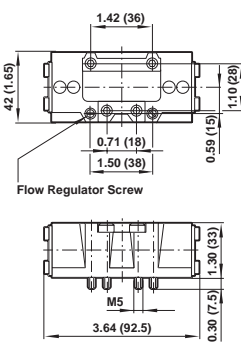

SXP *574-1 Models
Single and Double Air Pilot Valves Size #2 (5/2)

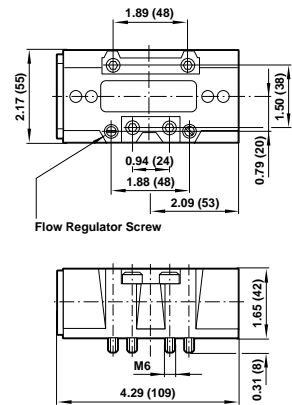

SXP 9*74-1 Models
Double Air Pilot, Spring Centered Valves
Size #2 (5/3)

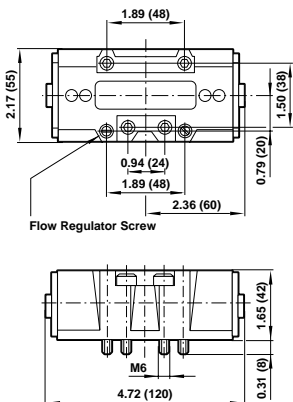

SXP *575-1 Models
Single and Double Air Pilot Valves
Size #3 (5/2)

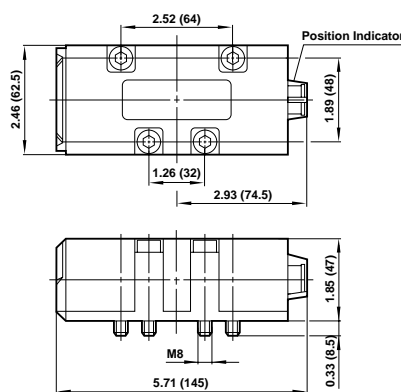

SXP 9*75-1 Models
Double Air Pilot, Spring Centered Valves
Size #3 (5/3)

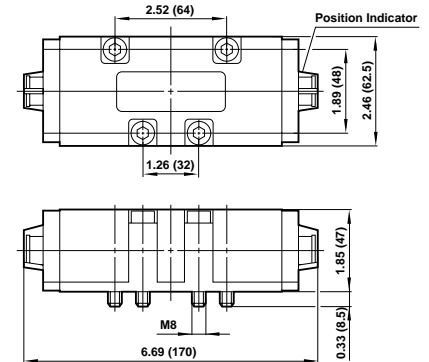

ISO Star Series Valves

5/2 and 5/3 solenoid and air pilot actuated valves

SXE 9574 – A70 – 0018 J B

Operator Type	Substitute
Solenoid pilot operated valve	SXE
Air pilot operated valve	SXP

Signal Duration	Substitute
Momentary (2-position double operator only)	0
Continuous	9

Internal Variations	Substitute
5-Port/2-position	5
5-Port/3-position, spring centered, all ports blocked	6
5-Port/3-position, spring centered, cylinder ports open to exhaust	7
5-Port/3-position, spring centered, cylinder ports open to pressure	8

Mounting Type	Substitute
ISO Star Series	7

Size	Substitute
Size 1	3
Size 2	4
Size 3	5

Solenoid Type	Substitute
Standard solenoid pilot operator	A
CNOMO solenoid pilot operator	Z

Valve Body Options		
Coils	Speed Control	Substitute
double solenoid	no	5
double solenoid	yes	6
single solenoid	no	7
single solenoid	yes	8

Connector	Substitute
No electrical connector	A
Cable grip	B
6 ft molded cable, 0-240 V a.c./V d.c.	C
6 ft molded cable, w/indicator light, surge suppression, 24V a.c./V d.c.	5
6 ft molded cable, 110-120 V a.c./V d.c.	6
Air pilot operated	Left Blank

Connector Interface	Substitute
22 mm coil with connector interface according to Industrial Standard	J
22 mm coil with connector interface according to DIN 43650 table "B"	L
30 mm coil with connector interface according to DIN 43650 table "A"	N
No coil or air pilot operated	Blank

Solenoid Voltage	Substitute
12V d.c.	2
24V d.c.	3
24V 50/60 Hz	4
48V 50/60 Hz	6
110/120V 50/60 Hz	8
220/240V 50/60 Hz	9
No coil or air pilot operated	Blank

Coil	Substitute
20 mm coil	1
30 mm coil	2

Manual Override	Substitute
Combination locking/nonlocking	00
Nonlocking	01
Low watt locking (CNOMO)	90

Pilot Supply/Integral Air Return Operator	Substitute
Internal / integral air return	0
Internal / spring return	1
External / integral air	5
External / spring return	6